



Scan me



AIR-CON

Scotch Yoke Pneumatic Actuators

- Suitable for use on low temperature to -60°C and high temperature to 200°C
- Suitable for use in severe environments such as chemical & petroleum and offshore industries
- Available for double acting, spring return, and air pressure from 45Psi to 90Psi
- Available for bi-directional travel stop adjustment at $\pm 6^{\circ}$



About Scotch Yoke Actuator

Flo-Tite Scotch Yoke pneumatic actuators are specifically designed for use with quarter-turn valves. The large output torque range offered by **Flo-Tite** ensures that our actuators match the operational characteristics of plug, ball, or butterfly valves; or any device requiring precise and reliable 90° rotary motion. The Scotch Yoke Actuators offer a large output torque range. For the spring return version, the output torque range is from 1,770in-lbs to 1,404,500in-lbs. For the double acting version, the output torque range is from 885in-lbs to 2,212,500in-lbs.

Robust and Lightweight Designing

Totally enclosed, weatherproof center body fabricated in carbon steel or ductile iron provides an excellent strength to weight ratio. The mechanism of piston and yoke has an advantage torque output.

Minimum Maintenance

Every **Flo-Tite** Scotch Yoke actuator is built to provide long and efficient service with minimum maintenance. The design, engineering, and materials used in their construction ensure optimum performance even in the harshest of environments.

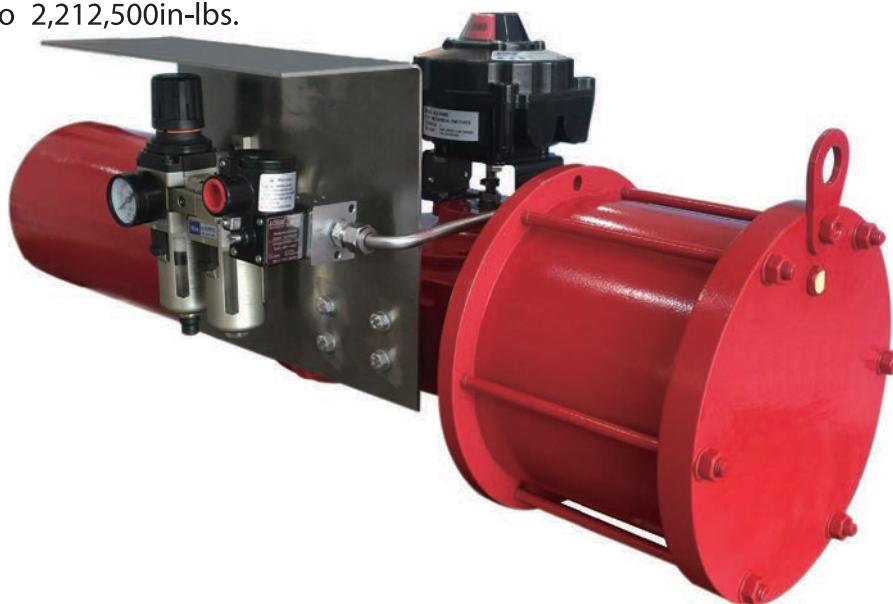

Extensive Product Range

Flo-Tite offers the most extensive line of fluid power valve actuators. Products include low and high pressure pneumatic, hydraulic, and pneumatic-hydraulic actuators and Spring-Diaphragm actuators.

Manual Override Options

A dependable manual override facility is an important part to many valve/actuator applications. **Flo-Tite** has a variety of override options available to meet virtually any requirement. Available options include open or closed screw manual override and hydraulic override.

Complete Control Solutions

Air Control component packages are a part of any actuator/valve installation. **Flo-Tite** has extensive experience in the design and assembly of all types of air control systems to satisfy any customer requirement for on/off, control, or ESD service. Packages can be mounted on a panel or in a cabinet and mounted either on the actuator or at a remote location.

Flo-Tite offers the most extensive line of fluid power valve actuators. Products include low and high pressure pneumatic, hydraulic, and pneumatic-hydraulic actuators and Spring-Diaphragm actuators.



ISO5211 and Namur Mounting

The Air-Con Series Actuator's connections are with ISO5211 interface to valve and Namur interface to limit switch box or valve positioners.



Stroke

Air-Con Yoke mechanism fitted with mechanical end stops (open or closed positions) to ensure adjustable range of $\pm 6^\circ$.

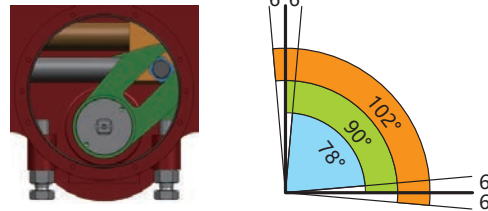

Water ingress protection

O-ring and seals (NBR for standard and PTFE for extreme cold) are fitted on bodies, caps, cylinders, and each connection to ensure water ingress is protected.



Operating Conditions

Working media is 3 - 6 bar pressure of air which is less than 40um filtered, dried, and lubricated. Air-Con Actuators are available to be used in high temperatures and extreme cold environments.



Corrosion Resistant

Air-Con Actuators have three coats of paint to resist severe weather, chemical, and petroleum environments. The inner surface of the cylinder is coated by chromium, enhancing corrosion resistance and self-lubricating.



Air-Con in Extreme Cold Environment

In extreme cold environment application, the PTFE is used for seal and low temperature pressure vessel steel (09MnNiDR) is used for each module. The body will be welded by 09MnNiDR.

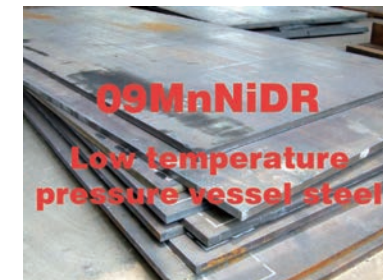



As for Air-Con Scotch Yoke Pneumatic Actuators, the double acting and spring return types are available on request. In the double acting actuator, one or two pneumatic cylinders are fitted to one or each sides and the actuator is operated by air pressure only. In the spring return actuator, one side is fitted with a pneumatic cylinder and the other side is fitted with a spring cartridge for emergency shut down (ESD) applications. The actuator is operated by air pressure in one position (open or closed) and by spring energy in another position (closed or open). Below illustrates the operating mechanism.

Air to Open Position

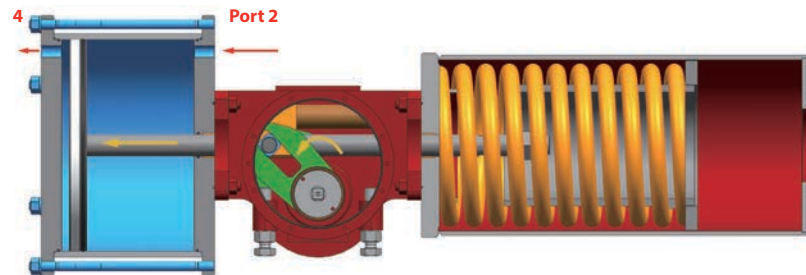

Air to port 2 forces the piston towards the left, causing the spring to be compressed and the yoke turns counterclockwise (to open the valve) while air is exhausted from port 4 (refer to the illustration above).

Spring Return to Closed Position

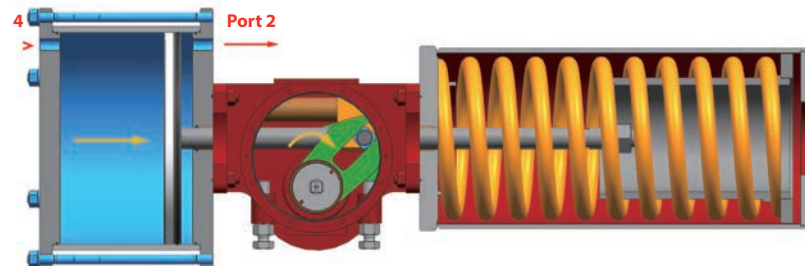

Loss of air pressure on port 2 cause the stored energy in the spring to force the piston towards the right and the yoke turns clockwise (closing the valve) while air is exhausted from port 2 and port 4 maintains breathed status with atmospheric environment(refer to the illustration above).

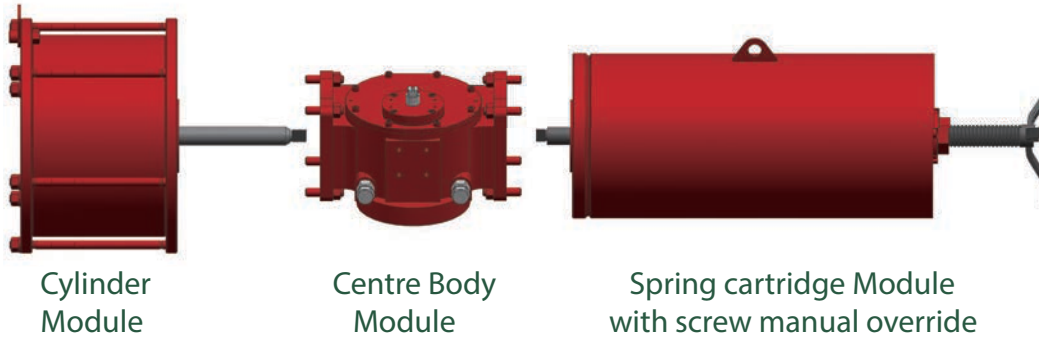

Flexible Modular Design

Flo-Tite Spring Yoke Series Actuator share a modular construction design. The center body is available in ten sizes. A pneumatic or hydraulic cylinder can be attached to either or both sides. A spring cartridge can also be fitted to either-side for ESD (emergency shut down) applications.

Interchangeability

The modules are removable and interchangeable while mounted to operate the valve used in certain specific applications. Note that only same size of modular unit can be interchange.

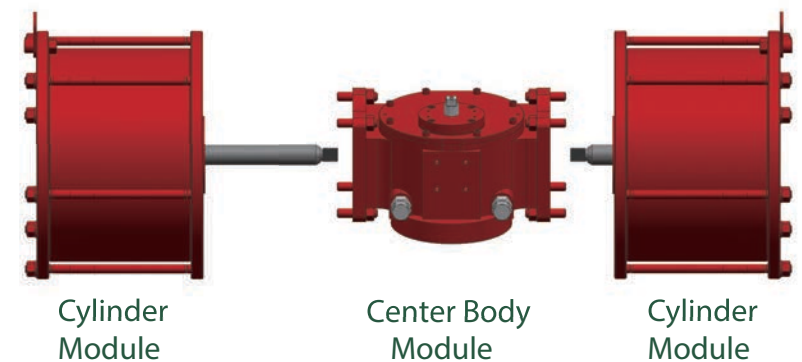
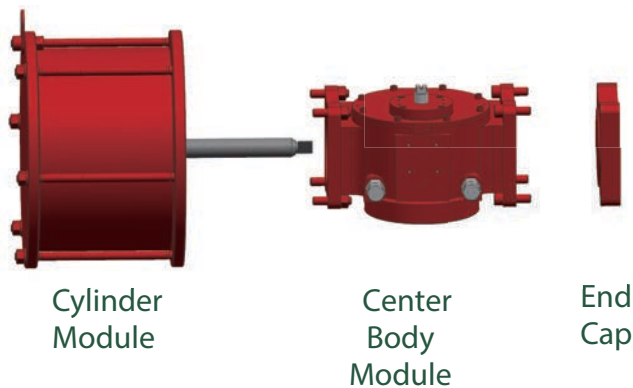
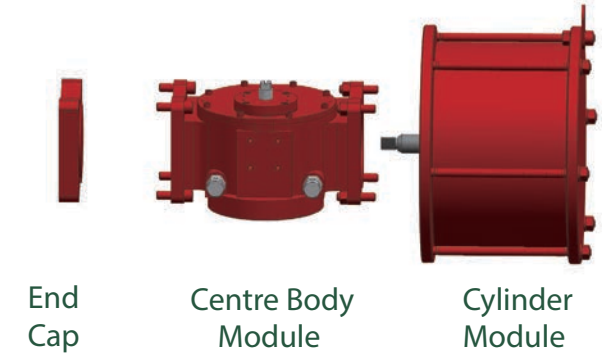
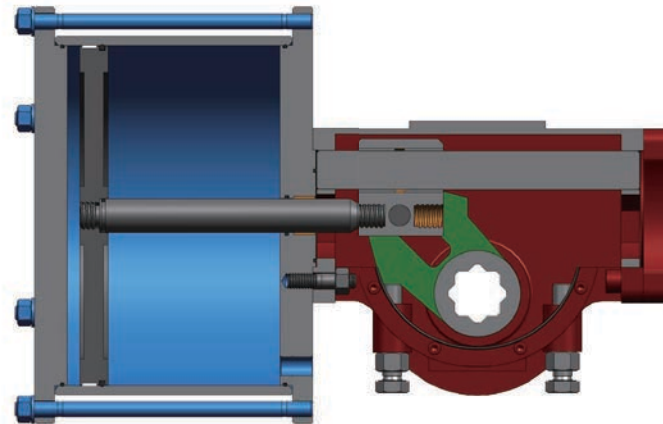



* Material Choice

The carbon steels and NBR O-rings are for standard temperature applications. For low temperature applications, the high-strength low-alloy steel (Q345E) and LNBR O-rings will be used. For extreme cold applications, low temperature, pressure vessel steel (09MnNi-DR), PTFE O-rings, and stainless steel 304 will be used.

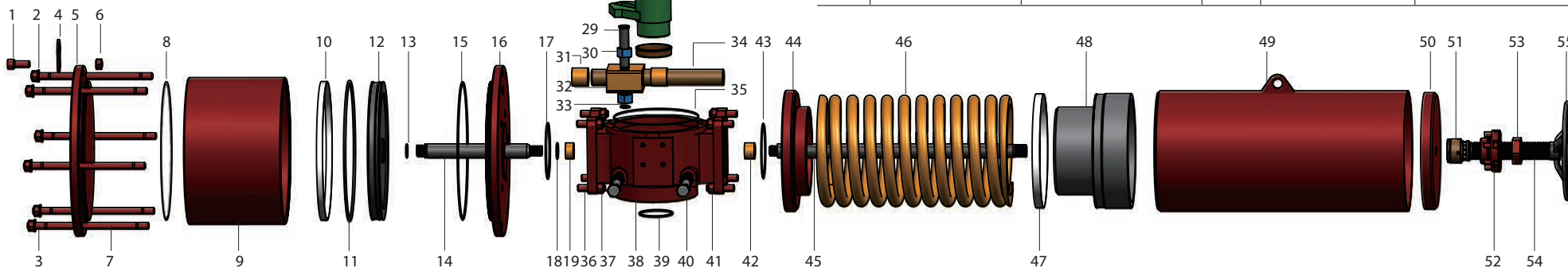

Body Module

No.	Name	Material	No.	Name	Material
20	Bolt	Carbon steel	31	Bushing	Alloy
21	Gland	Stainless steel	32	Gulde	Carbon steel
22	O-ring	NBR*	33	Snap spring	65Mn
23	Namur indicator	Stainless steel	34	Guide	Carbon steel
24	Bolt	Carbon steel	35	O-ring	NBR*
25	Lid	Ductile Iron	36	Stud	Carbon steel
26	O-ring	NBR*	37	Nut	Carbon steel
27	Bushing	Alloy	38	Body	Ductile Iron
28	Yoke	Carbon steel*	39	O-ring	NBR*
29	Pin	Alloy steel	40	Regulat screw	Carbon steel
30	Slider	Copper alloy	41	Lock nut	Carbon steel

Cylinder Module

No.	Name	Material	No.	Name	Material
1	Bolt	Carbon steel*	11	O-ring	NBR*
2	Nut	Carbon steel	12	Piston	Carbon steel*
3	Gasket	Carbon steel	13	O-ring	NBR*
4	Lug	Carbon steel	14	Push rod	Carbon steel
5	Rear end	Carbon steel*	15	O-ring	NBR*
6	Nut	Carbon steel	16	Front end	Carbon steel*
7	Screw	Carbon steel	17	O-ring	NBR*
8	O-ring	NBR*	18	O-ring	NBR*
9	Cylinder barrel	Carbon steel*	19	Bushing	Alloy
10	Guidance tape	PTFE			

Spring Module

No.	Name	Material
42	Bushing	Alloy
43	O-ring	NBR*
44	Spring cover	Carbon steel*
45	Spring shaft	Carbon steel
46	Spring	Spring steel
47	Guidance tape	PTFE
48	Spring seat	Carbon steel*
49	Spring body	Carbon steel*
50	End cover	Carbon steel*
51	Coupling	Carbon steel
52	Lock device	Carbon steel
53	Nut	Carbon steel
54	Wirerod	Carbon steel
55	Hand wheel	Cast iron

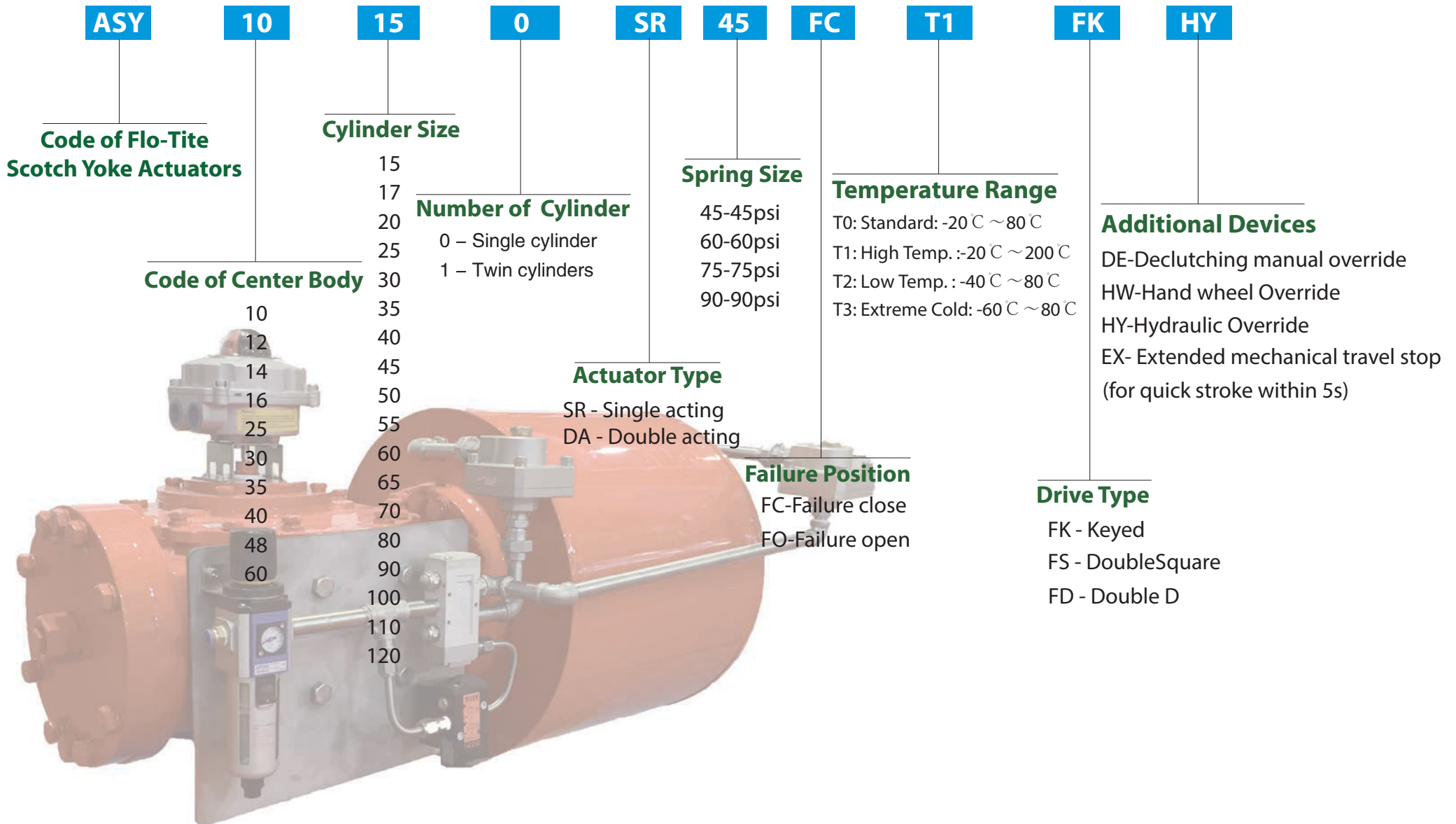



Output Torque

Output Torque of ASY Series Actuator with Spring Return (SR)

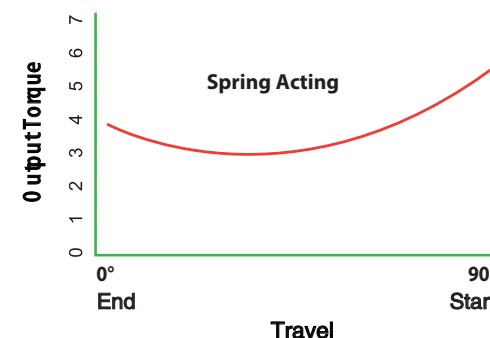
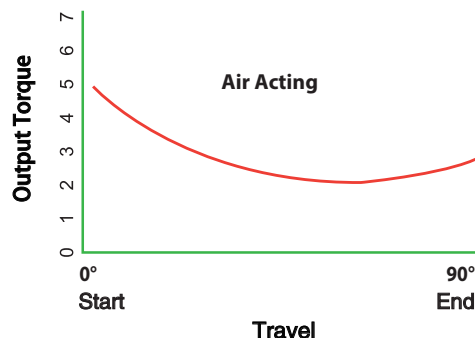
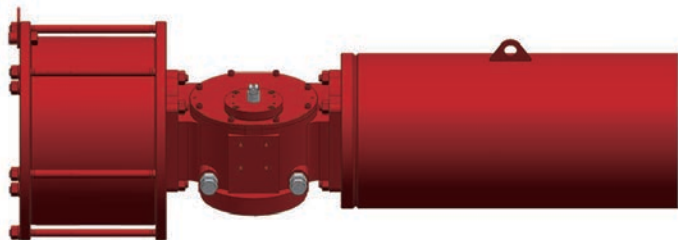

Unit : in.lbs

Model	45Psi						60Psi						75Psi						90Psi					
	Spring Acting			Air Acting			Spring Acting			Air Acting			Spring Acting			Air Acting			Spring Acting			Air Acting		
	Start	Run	End	Start	Run	End	Start	Run	End	Start	Run	End	Start	Run	End	Start	Run	End	Start	Run	End	Start	Run	End
ASY10-150SR	1749	854	1095	1859	874	1165	2335	1139	1460	2481	1165	1553	2921	1424	1825	3104	1456	1941	3497	1708	2190	3726	1747	2330
ASY10-170SR	2243	1097	1406	2390	1122	1496	3003	1463	1875	3195	1496	1995	3754	1829	2344	3992	1870	2494	4495	2194	2813	4779	2244	2992
ASY12-170SR	2811	1372	1758	2994	1403	1870	3754	1829	2344	3992	1870	2494	4687	2286	2930	4990	2338	3117	5621	2743	3516	5978	2805	3740
ASY12-200SR	3891	1898	2433	4138	1941	2589	5191	2531	3244	5521	2589	3451	6491	3164	4055	6903	3236	4314	7782	3797	4867	8276	3883	5177
ASY14-200SR	4669	2278	2920	4971	2330	3106	6226	3037	3893	6628	3106	4142	7782	3797	4867	8285	3883	5177	9338	4556	5840	9933	4659	6213
ASY14-250SR	7297	3559	4562	7764	3640	4854	9732	4746	6083	10355	4854	6471	12167	5932	7604	12945	6067	8089	14593	7119	9125	15527	7280	9707
ASY14-300SR	10510	5125	6570	11178	5242	6989	14017	6834	8760	14914	6989	9319	17523	8542	10950	18640	8736	11649	21020	10251	13140	22357	10484	13978
ASY16-250SR	9119	4449	5703	9704	4550	6067	12167	5932	7604	12945	6067	8089	15207	7415	9505	16177	7584	10112	18246	8898	11406	19409	9100	12134
ASY16-300SR	13138	6407	8212	13980	6552	8736	17523	8542	10950	18640	8736	11649	21899	10678	13687	23300	10921	14561	26275	12813	16424	27951	13105	17473
ASY16-350SR	17880	8720	11178	19024	8918	11891	23849	11627	14904	25369	11891	15855	29809	14534	18630	31714	14864	19819	35760	17440	22355	38049	17837	23782
ASY25-350SR	21460	10464	13413	22833	10702	14269	28619	13952	17884	30441	14269	19026	35769	17440	22355	38049	17837	23782	42919	20929	26827	45657	21404	28539
ASY25-400SR	28024	13668	17519	29818	13978	18638	37371	18223	23359	39761	18638	24850	46719	22779	29199	49703	23297	31063	56057	27335	35039	59637	27956	37275
ASY25-450SR	35476	17298	22173	37738	17691	23588	47305	23064	29564	50326	23588	31451	59124	28830	36955	62905	29485	39314	70953	34596	44346	75475	35382	47177
ASY30-450SR	39413	19220	24637	41931	19657	26209	52560	25627	32849	55911	26209	34946	65698	32033	41061	69891	32762	43682	78835	38440	49273	83861	39314	52418
ASY30-500SR	48660	23729	30416	51773	24268	32357	64883	31638	40554	69030	32357	43143	81106	39548	50693	86288	40446	53928	97329	47457	60831	103536	48536	64714



Output Torque of ASY Series Actuator with Spring Return (SR)

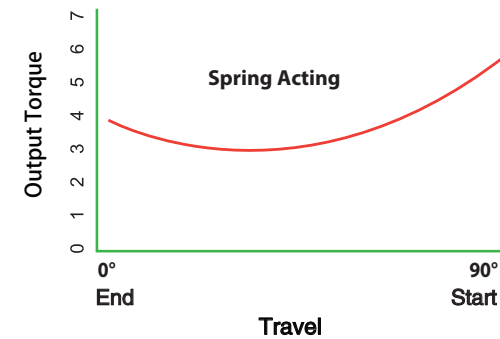
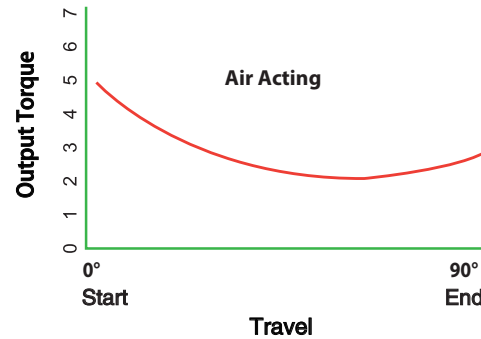
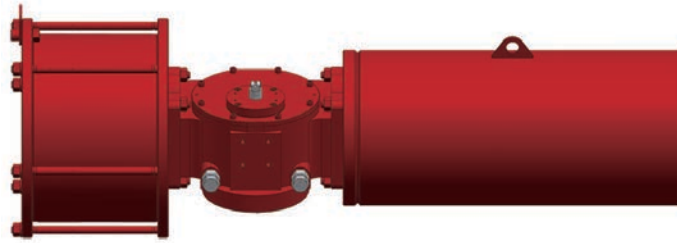

Unit : in.lbs

Model	45Psi						60Psi						75Psi						90Psi					
	Spring Acting			Air Acting			Spring Acting			Air Acting			Spring Acting			Air Acting			Spring Acting			Air Acting		
	Start	Run	End	Start	Run	End	Start	Run	End	Start	Run	End	Start	Run	End	Start	Run	End	Start	Run	End	Start	Run	End
ASY30-550SR	58877	28711	36803	62365	29364	39152	78515	38282	49071	83523	39152	52203	98143	47852	61338	104406	48940	65253	117763	57423	73606	125279	58728	78304
ASY35-550SR	82433	40196	51524	86782	41110	54813	109917	53595	68699	116930	54813	73084	137401	66993	85873	146171	68516	91355	164876	80392	103048	175395	82219	109626
ASY35-600SR	98107	47837	61318	104369	48924	65232	130809	63782	81757	139159	65232	86976	163511	79728	102197	173948	81540	108720	196214	95673	122636	208738	97848	130464
ASY35-700SR	133528	65111	83460	142061	66591	88788	178050	86815	111281	189411	88788	118384	222562	108518	139101	236771	110985	147980	267066	130222	166921	284112	133182	177575
ASY40-600SR	119127	58087	74457	126735	59408	79210	158842	77450	99277	168977	79210	105613	198557	96812	124096	211228	99013	132017	238263	116175	148915	253470	118815	158420
ASY40-700SR	162147	79063	101345	172502	80860	107814	216199	105418	135126	230005	107814	143752	270252	131772	168908	287500	134767	179689	324295	158127	202690	345004	161721	215627
ASY40-800SR	211787	103266	132369	225309	105613	140818	282391	137689	176492	300409	140818	187757	352987	172111	220615	375518	176022	234696	423573	206533	264738	450608	211227	281636
ASY48-800SR	249158	121490	155728	265070	124251	165668	332223	161987	207637	353426	165668	220891	415279	202483	259547	441783	207085	276113	498325	242980	311456	530130	248502	331336
ASY48-900SR	315341	153761	197093	335482	157255	209674	420470	205014	262791	447303	209674	279565	525580	256268	328489	559134	262092	349456	630691	307521	394187	670955	314511	419347
ASY48-1000SR	389315	189828	243325	414171	194142	258856	519089	253104	324433	552231	258856	345142	648864	316380	405542	690282	323571	431427	778638	379656	486650	828333	388285	517713
ASY60-800SR	323910	157937	202446	344592	161526	215369	431886	210583	269929	459452	215369	287158	539853	263228	337411	574313	269211	358948	647820	315874	404893	689174	323053	430737
ASY60-900SR	409950	199889	256221	436125	204432	272576	546610	266519	341628	581491	272576	363434	683260	333148	427035	726866	340720	454293	819901	399778	512442	872241	408864	545152
ASY60-1000SR	506107	246776	316323	538425	252385	336513	674819	329035	421763	717894	336513	448684	843530	411294	527204	897372	420642	560856	1012232	493553	632645	1076841	504770	673027
ASY60-1100SR	612399	298599	382750	651491	305386	407181	816532	398133	510334	868652	407181	542908	1020664	497666	637917	1085813	508976	678635	1224797	597199	765501	1302973	610772	814362



Output Torque

Double Acting Output Torque of ASY Series Actuator (DA)

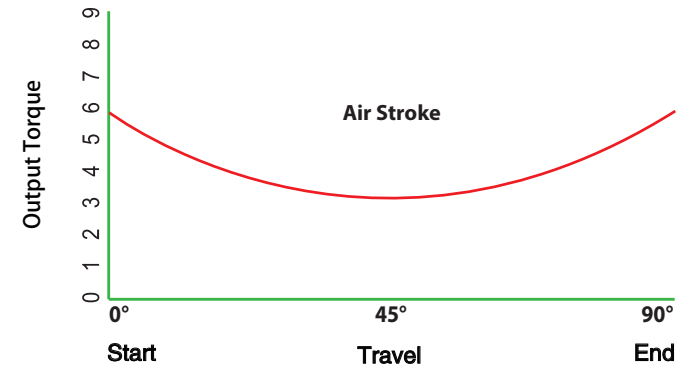
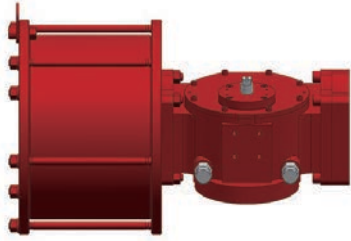

Unit : in.lbs

Model	45Psi			60Psi			75Psi			90Psi		
	Start	Running	End	Start	Running	End	Start	Running	End	Start	Running	End
ASY10-150DA	2801	1584	2801	3708	1904	3708	4660	2335	4660	5594	2838	5594
ASY10-170DA	3644	2243	3644	4788	2838	4788	5987	3030	5987	- *	- *	- *
ASY12-170DA	4495	2609	4495	5987	3543	5987	7480	4349	7480	9036	5164	9036
ASY12-200DA	6308	3580	6308	8285	4138	8285	10355	5173	10355	12424	7461	12424
ASY14-200DA	7681	4660	7681	10144	6216	10144	12680	7764	12680	15289	9320	15289
ASY14-250DA	11856	7278	11856	15893	9704	15893	19885	12131	19885	- *	- *	- *
ASY14-300DA	17047	10483	17047	- *	- *	- *	- *	- *	- *	- *	- *	- *
ASY16-250DA	14877	9100	14877	19812	12131	19812	24829	15170	24829	30304	18200	30304
ASY16-300DA	21377	13101	21377	28573	17477	28573	35604	21844	35604	- *	- *	- *
ASY16-350DA	29123	17834	29123	38809	23785	38809	- *	- *	- *	- *	- *	- *
ASY25-350DA	35925	21405	35925	47946	28537	47946	59939	35678	59939	71969	42810	71969
ASY25-400DA	45639	27960	45639	60809	37280	60809	76107	46591	76107	- *	- *	- *
ASY25-450DA	57751	35385	57751	77022	47177	77022	- *	- *	- *	- *	- *	- *
ASY30-450DA	70678	39312	70678	94216	52423	94216	117681	65524	117681	141273	78625	141273
ASY30-500DA	87102	48532	87102	116216	64718	116216	145265	80895	145265	- *	- *	- *

- * The torque is more than the maximum flange torque value stipulated by ISO5211.



Double Acting Output Torque of ASY Series Actuator (DA)

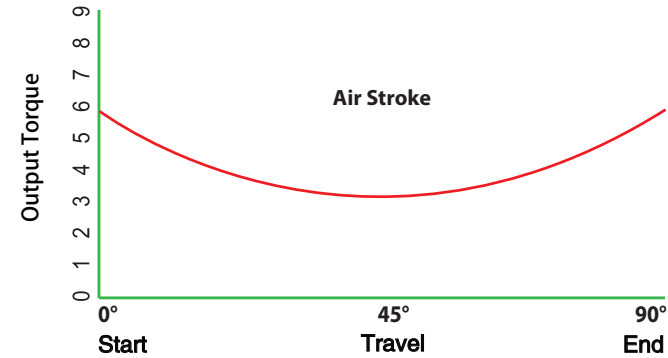
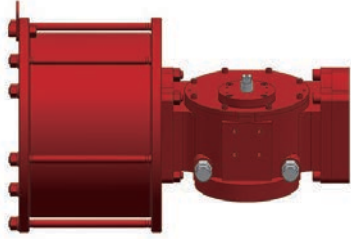

Unit : in.lbs

Model	45Psi			60Psi			75Psi			90Psi		
	Start	Running	End	Start	Running	End	Start	Running	End	Start	Running	End
ASY30-550DA	105468	58730	105468	140651	83358	140651	- *	- *	- *	- *	- *	- *
ASY35-550DA	134306	82223	134306	178993	109624	178993	223762	137035	223762	268466	164436	268466
ASY35-600DA	159794	97850	159794	212977	130461	212977	266205	163081	266205	319479	195692	319479
ASY35-700DA	217445	133180	217445	290018	177574	290018	- *	- *	- *	- *	- *	- *
ASY40-600DA	- **	- **	- **	- *	- *	- *	323635	198026	323635	387969	237632	387969
ASY40-700DA	- **	- **	- **	351925	215632	351925	440098	269537	440098	528080	323443	528080
ASY40-800DA	344985	270847	344985	460670	364852	460670	574817	352044	574817	- *	- *	- *
ASY48-800DA	- **	- **	- **	- *	- *	- *	676219	414171	676219	811514	497007	811514
ASY48-900DA	- **	- **	- **	684459	419344	684459	855880	524189	855880	1026661	629024	1026661
ASY48-1000DA	634316	388289	634316	845489	517716	845489	1055774	647143	1055774	- *	- *	- *
ASY60-800DA	- **	- **	- **	- *	- *	- *	- *	- *	- *	1095151	645513	1095151
ASY60-900DA	- **	- **	- **	924352	545154	924352	1155392	681438	1155392	1386606	817731	1386606
ASY60-1000DA	855789	504770	855789	1141092	692625	1141092	1426385	841287	1426385	1734447	1038801	1734447
ASY60-1100DA	1035285	610769	1035285	1380499	814362	1380499	1725448	1017954	1725448	2070552	1221547	2070552

- ** The torque is too small for operation.

- * The torque is more than the maximum flange torque value stipulated by ISO5211.



Output Torque

Double Acting Output Torque of ASY Series Actuator (DA)

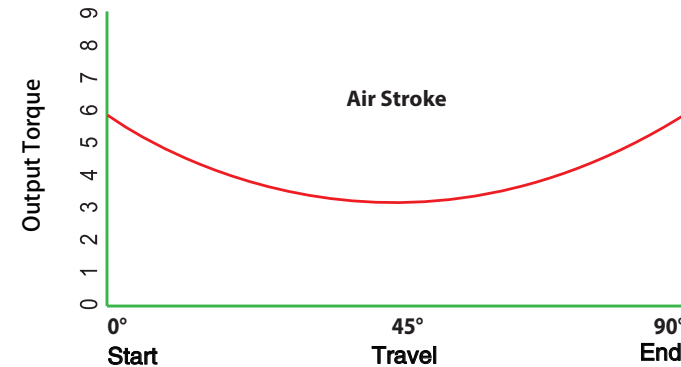
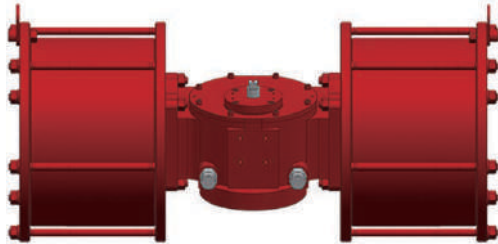

Unit : in.lbs

Model	45Psi			60Psi			70Psi			90Psi		
	Start	Running	End	Start	Running	End	Start	Running	End	Start	Running	End
ASY16-141-DA	9659	5136	9659	12881	6848	12881	16095	8560	16095	19317	10272	19317
ASY16-161-DA	12616	6711	12616	16818	8945	16818	21020	11178	21020	25232	13421	25232
ASY16-201-DA	19711	10483	19711	26275	13980	26275	32849	17477	32849	39422	20965	39422
ASY25-201-DA	23648	12579	23648	31530	16772	31530	39422	20965	39422	47305	25158	47305
ASY25-251-DA	36959	19656	36959	49273	26211	49273	61596	32757	61596	73910	39312	73910
ASY25-301-DA	53219	28308	53219	70953	37738	70953	- *	- *	- *	- *	- *	- *
ASY30-301-DA	59124	31448	59124	78835	41931	78835	98546	52423	98546	118257	62905	118257
ASY30-351-DA	80483	42810	80483	107308	57073	107308	134132	71346	134132	160957	85619	160957
ASY30-401-DA	105120	55911	105120	140157	74551	140157	- *	- *	- *	- *	- *	- *
ASY35-401-DA	147160	78277	147160	196214	104369	196214	245267	130461	245267	294330	156553	294330
ASY35-451-DA	186253	99068	186253	248334	132091	248334	- *	- *	- *	- *	- *	- *

- * The torque is more than the maximum flange torque value stipulated by ISO5211.



Double Acting Output Torque of ASY Series Actuator (DA)

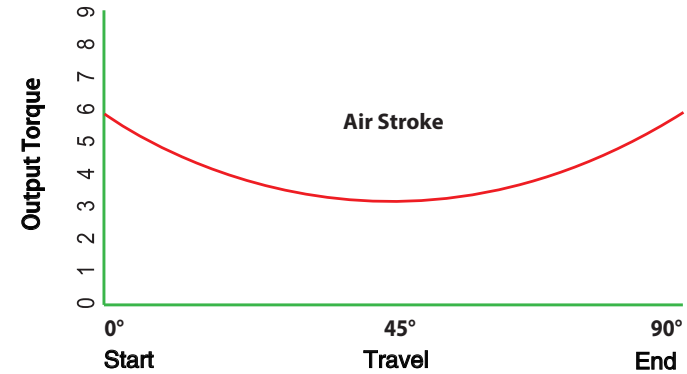
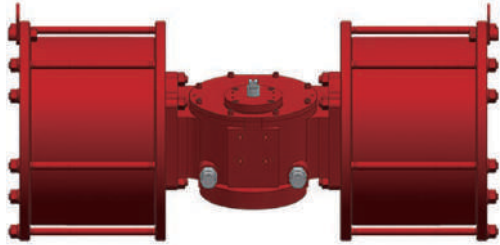

Unit : in.lbs

Model	45Psi			60Psi			70Psi			90Psi		
	Start	Running	End	Start	Running	End	Start	Running	End	Start	Running	End
ASY35-501-DA	229941	122313	229941	306588	163081	306588	383236	203849	383236	459883	244617	459883
ASY40-501-DA	279214	148515	279214	372286	198026	372286	465357	247528	465357	558429	297040	558429
ASY40-551-DA	337853	179707	337853	450471	239609	450471	563089	299511	563089	- *	- *	- *
ASY40-601-DA	402068	213865	402068	536090	285156	536090	- *	- *	- *	- *	- *	- *
ASY48-601-DA	473020	251612	473020	630700	335482	630700	788370	419344	788370	946050	503214	946050
ASY48-651-DA	555142	295291	555142	740196	393718	740196	925240	492155	925240	1110294	590582	1110294
ASY48-701-DA	643838	342468	643838	858453	456623	858453	1073059	570779	1073059	- *	- *	- *
ASY48-801-DA	840930	447303	840930	1121243	596405	1121243	- *	- *	- *	- *	- *	- *
ASY60-801-DA	1093210	581491	1093210	1457613	775324	1457613	1822017	969157	1822017	2186420	1162991	2186420
ASY60-901-DA	1383594	735957	1383594	1844795	981270	1844795	2305996	1226592	2305996	- *	- *	- *
ASY60-1001-DA	1708145	908587	1708145	2277523	1211449	2277523	- *	- *	- *	- *	- *	- *

- * The torque is more than the maximum flange torque value stipulated by ISO5211.



Dimension of ASY Series Spring Return Actuator(SR)

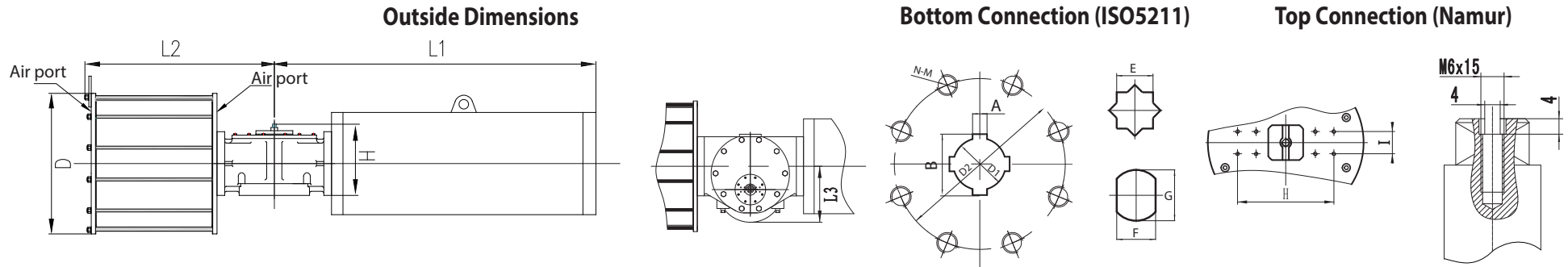

Unit : inches

Model	Outside Dimensions					Female Drive Connection						Flange Connection			Top Connection (Namur)		Air Port
						Keyed (FK)			Double Square (FS)		Double D (FD)						
	D	L1	L2	L3	H	A	B	D1	E	F	G	D2	N-M	ISO5211	I	H	
ASY10-150SR	8.27	17.52	9.45	3.15	6.50	0.31	1.36	1.10	0.87	0.87	1.11	4.02	4-M10	F10	1.18	3.15	3/8"NPT
ASY10-170SR	9.06	17.52	9.45	3.15	6.50	0.31	1.36	1.10	0.87	0.87	1.11	4.02	4-M10	F10	1.18	3.15	3/8"NPT
ASY12-170SR	9.06	24.41	11.42	3.54	6.69	0.39	1.68	1.42	1.06	1.06	1.43	4.92	4-M12	F12	1.18	3.15	3/8"NPT
ASY12-200SR	10.24	24.41	11.42	3.54	6.69	0.39	1.68	1.42	1.06	1.06	1.43	4.92	4-M12	F12	1.18	3.15	3/8"NPT
ASY14-200SR	10.24	26.77	14.57	5.91	7.87	0.47	1.91	1.65	1.42	1.42	1.90	5.51	4-M16	F14	1.18	3.15	3/8"NPT
ASY14-250SR	12.20	26.77	14.57	5.91	7.87	0.47	1.91	1.65	1.42	1.42	1.90	5.51	4-M16	F14	1.18	3.15	1/2"NPT
ASY14-300SR	14.57	26.77	14.57	5.91	7.87	0.47	1.91	1.65	1.42	1.42	1.90	5.51	4-M16	F14	1.18	3.15	1/2"NPT
ASY16-250SR	12.20	35.83	18.50	7.09	8.27	0.71	2.71	2.36	1.81	1.81	2.37	6.50	4-M20	F16	1.18	3.15	1/2"NPT
ASY16-300SR	14.57	35.83	18.50	7.09	8.27	0.71	2.71	2.36	1.81	1.81	2.37	6.50	4-M20	F16	1.18	3.15	1/2"NPT
ASY16-350SR	16.93	38.19	18.50	7.09	8.27	0.71	2.71	2.36	1.81	1.81	2.37	6.50	4-M20	F16	1.18	3.15	1/2"NPT
ASY16-400SR	18.90	38.19	18.50	7.09	8.27	0.71	2.71	2.36	1.81	1.81	2.37	6.50	4-M20	F16	1.18	3.15	3/4"NPT
ASY25-350SR	16.93	40.94	21.26	9.45	9.06	0.79	3.22	2.83	2.17	2.17	2.84	10.00	8-M16	F25	1.18	3.15	1/2"NPT
ASY25-400SR	18.90	40.94	21.26	9.45	9.06	0.79	3.22	2.83	2.17	2.17	2.84	10.00	8-M16	F25	1.18	3.15	3/4"NPT



Dimension of ASY Series Spring Return Actuator(SR)

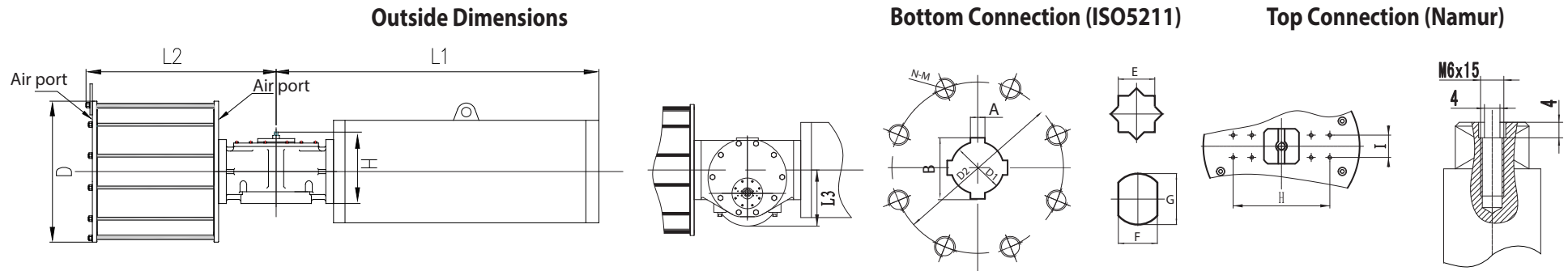

Unit : inches

Model	Outside Dimensions					Female Drive Connection						Flange Connection			Top Connection (Namur)		Air Port
						Keyed (FK)			Double Square (FS)	Double D (FD)							
	D	L1	L2	L3	H	A	B	D1	E	F	G	D2	N-M	ISO5211	I	H	
ASY25-450SR	20.87	43.31	21.26	9.45	9.06	0.79	3.22	2.83	2.17	2.17	2.84	10.00	8-M16	F25	1.18	3.15	3/4"NPT
ASY30-450SR	20.87	45.08	24.41	10.83	10.83	0.87	3.57	3.15	2.95	2.95	3.89	11.73	8-M20	F30	1.18	5.12(3.15)	3/4"NPT
ASY30-500SR	22.83	45.08	24.41	10.83	10.83	0.87	3.57	3.15	2.95	2.95	3.89	11.73	8-M20	F30	1.18	5.12(3.15)	3/4"NPT
ASY30-550SR	24.80	47.44	24.41	10.83	10.83	0.87	3.57	3.15	2.95	2.95	3.89	11.73	8-M20	F30	1.18	5.12(3.15)	3/4"NPT
ASY35-550SR	24.80	55.12	32.48	13.68	12.20	1.10	4.44	3.94	-	-	-	14.02	8-M30	F35	1.18	5.12(3.15)	3/4"NPT
ASY35-600SR	27.17	47.44	31.89	13.78	12.20	1.10	4.44	3.94	-	-	-	14.02	8-M30	F35	1.18	5.12(3.15)	1"NPT
ASY35-700SR	31.10	47.44	31.89	13.78	12.20	1.10	4.44	3.94	-	-	-	14.02	8-M30	F35	1.18	5.12(3.15)	1"NPT
ASY35-800SR	35.43	53.35	31.89	13.78	12.20	1.10	4.44	3.94	-	-	-	14.02	8-M30	F35	1.18	5.12(3.15)	1 1/2"NPT
ASY40-600SR	27.17	70.08	37.80	16.14	13.78	1.57	7.04	6.30	-	-	-	15.98	8-M36	F40	1.18	5.12(3.15)	1"NPT
ASY40-700SR	31.10	70.08	37.80	16.14	13.78	1.57	7.04	6.30	-	-	-	15.98	8-M36	F40	1.18	5.12(3.15)	1"NPT
ASY40-800SR	35.43	70.08	37.80	16.14	13.78	1.57	7.04	6.30	-	-	-	15.98	8-M36	F40	1.18	5.12(3.15)	1 1/2"NPT
ASY40-900SR	40.16	71.26	37.80	16.14	13.78	1.57	7.04	6.30	-	-	-	15.98	8-M36	F40	1.18	5.12(3.15)	2"NPT



Dimensions of ASY Series Spring Return Actuator(SR)

Outside Dimensions

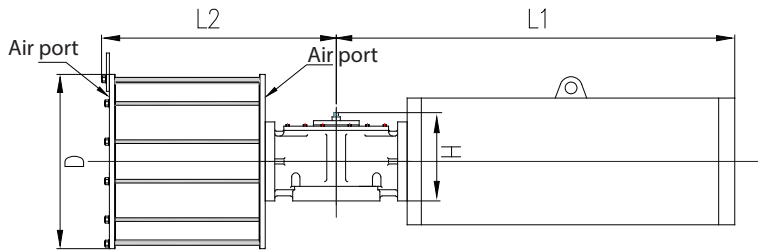

Bottom Connection (ISO5211)

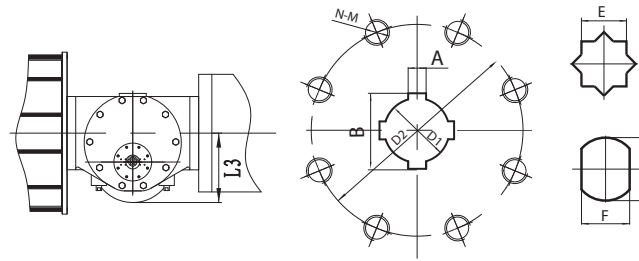

Top Connection (Namura)

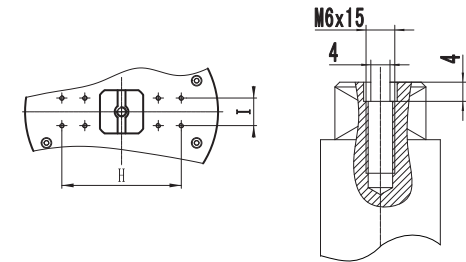

Unit : inches

Model	Outside Dimensions					Female Drive Connection						Flange Connection			Top Connection (Namura)		Air Port
						Keyed (FK)			Double Square (FS)		Double D (FD)						
	D	L1	L2	L3	H	A	B	D1	E	F	G	D2	N-M	ISO5211	I	H	
ASY40-1000SR	44.49	71.26	37.80	16.14	13.78	1.57	7.04	6.30	-	-	-	15.98	8-M36	F40	1.18	5.12(3.15)	2"NPT
ASY48-800SR	35.43	88.98	44.09	18.90	16.54	1.77	7.91	7.09	-	-	-	19.02	12-M36	F48	1.18	5.12(3.15)	1 1/2"NPT
ASY48-900SR	40.16	88.98	44.09	18.90	16.54	1.77	7.91	7.09	-	-	-	19.02	12-M36	F48	1.18	5.12(3.15)	2"NPT
ASY48-1000SR	44.49	88.98	44.09	18.90	16.54	1.77	7.91	7.09	-	-	-	19.02	12-M36	F48	1.18	5.12(3.15)	2"NPT
ASY48-1100SR	49.21	96.46	44.09	18.90	16.54	1.77	7.91	7.09	-	-	-	19.02	12-M36	F48	1.18	5.12(3.15)	2"NPT
ASY48-1200SR	53.94	96.46	44.09	18.90	16.54	1.77	7.91	7.09	-	-	-	19.02	12-M36	F48	1.18	5.12(3.15)	2"NPT
ASY60-800SR	35.43	107.68	53.74	23.74	19.69	1.97	9.56	8.66	-	-	-	23.74	20-M36	F60	1.18	5.12(3.15)	1 1/2"NPT
ASY60-900SR	40.16	107.68	53.74	23.74	19.69	1.97	9.56	8.66	-	-	-	23.74	20-M36	F60	1.18	5.12(3.15)	2"NPT
ASY60-1000SR	44.49	107.68	53.74	23.74	19.69	1.97	9.56	8.66	-	-	-	23.74	20-M36	F60	1.18	5.12(3.15)	2"NPT
ASY60-1100SR	49.21	107.68	53.74	23.74	19.69	1.97	9.56	8.66	-	-	-	23.74	20-M36	F60	1.18	5.12(3.15)	2"NPT
ASY60-1200SR	53.94	128.35	53.74	23.74	19.69	1.97	9.56	8.66	-	-	-	23.74	20-M36	F60	1.18	5.12(3.15)	2"NPT
ASY60-1300SR	58.27	137.40	53.74	23.74	19.69	1.97	9.56	8.66	-	-	-	23.74	20-M36	F60	1.18	5.12(3.15)	2"NPT



Double Acting Dimensions of ASY Series Actuator (DA)

Outside Dimensions

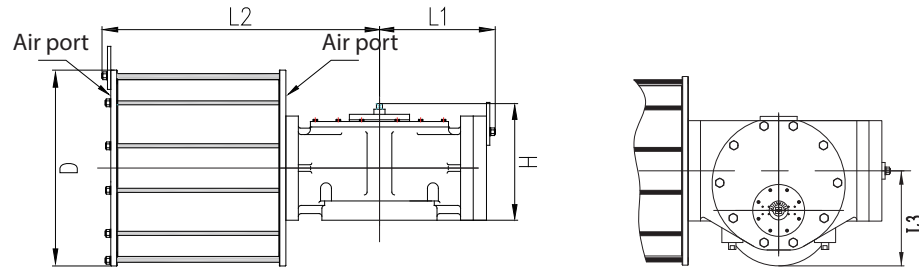

Bottom Connection (ISO5211)

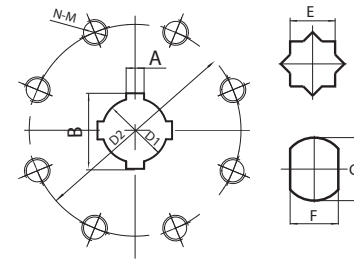

Top Connection (Napur)

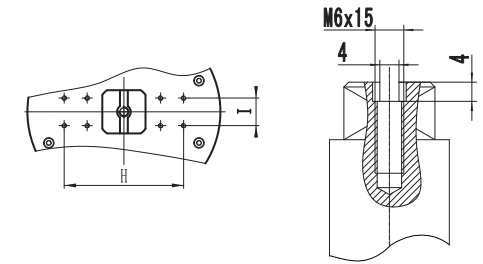

Unit : inches

Model	Outside Dimensions					Female Drive Connection						Flange Connection			Top Connection (Napur)		Air Port
						Keyed (FK)			Double Square (FS)	Double D (FD)							
	D	L1	L2	L3	H	A	B	D1		E	F	G	D2	N-M	ISO5211	I	
ASY14-200DA	10.63	6.69	14.57	6.69	7.87	0.47	1.91	1.65	1.42	1.42	1.90	5.51	4-M16	F14	1.18	3.15	3/8"NPT
ASY14-250DA	12.60	6.69	14.57	6.69	7.87	0.47	1.91	1.65	1.42	1.42	1.90	5.51	4-M16	F14	1.18	3.15	1/2"NPT
ASY14-300DA	14.96	6.69	14.57	6.69	7.87	0.47	1.91	1.65	1.42	1.42	1.90	5.51	4-M16	F14	1.18	3.15	1/2"NPT
ASY16-250DA	12.60	7.48	17.32	7.09	8.27	0.71	2.71	2.36	1.81	1.81	2.37	6.50	4-M20	F16	1.18	3.15	1/2"NPT
ASY16-300DA	14.96	7.48	17.32	7.09	8.27	0.71	2.71	2.36	1.81	1.81	2.37	6.50	4-M20	F16	1.18	3.15	1/2"NPT
ASY16-350DA	16.93	7.48	17.32	7.09	8.27	0.71	2.71	2.36	1.81	1.81	2.37	6.50	4-M20	F16	1.18	3.15	1/2"NPT
ASY25-350DA	16.93	9.06	20.08	8.27	9.06	0.79	3.22	2.83	2.17	2.17	2.84	10.00	8-M16	F25	1.18	3.15	1/2"NPT
ASY25-400DA	18.90	9.06	20.08	8.27	9.06	0.79	3.22	2.83	2.17	2.17	2.84	10.00	8-M16	F25	1.18	3.15	3/4"NPT
ASY25-450DA	20.87	9.06	20.08	8.27	9.06	0.79	3.22	2.83	2.17	2.17	2.84	10.00	8-M16	F25	1.18	3.15	3/4"NPT
ASY30-450DA	20.87	11.02	22.83	9.84	10.83	0.87	3.57	3.15	2.95	2.95	3.87	11.73	8-M20	F30	1.18	5.12(3.15)	3/4"NPT
ASY30-500DA	22.83	11.02	22.83	9.84	10.83	0.87	3.57	3.15	2.95	2.95	3.87	11.73	8-M20	F30	1.18	5.12(3.15)	3/4"NPT
ASY30-550DA	25.20	11.02	22.83	9.84	10.83	0.87	3.57	3.15	2.95	2.95	3.87	11.73	8-M20	F30	1.18	5.12(3.15)	3/4"NPT



Double Acting Dimensions of ASY Series Actuator (DA)

Outside Dimensions

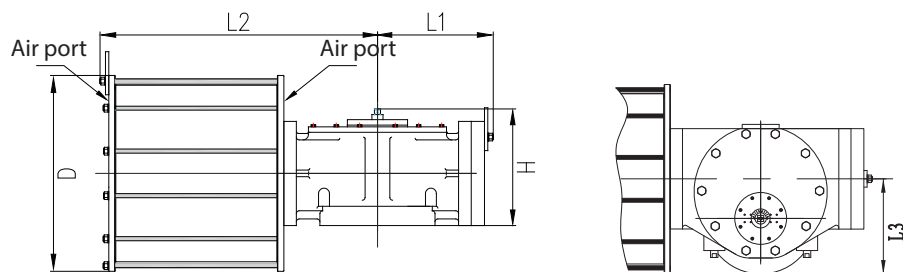

Bottom Connection (ISO5211)

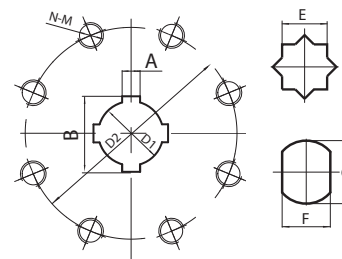

Top Connection (Namur)

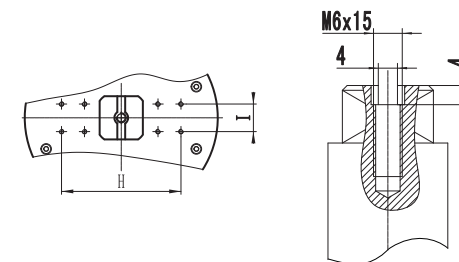

Unit : inches

Model	Outside Dimensions					Female Drive Connection						Flange Connection			Top Connection (Namur)		Air Port
						Keyed (FK)			D1	Double Square (FS)							
	D	L1	L2	L3	H	A	B	D1		E	F	G	D2	N-M	ISO5211	I	
ASY35-550DA	25.20	12.99	32.68	13.78	12.20	1.10	4.44	3.94	-	-	-	14.02	8-M30	F35	1.18	5.12(3.15)	3/4"NPT
ASY35-600DA	27.17	12.99	32.68	13.78	12.20	1.10	4.44	3.94	-	-	-	14.02	8-M30	F35	1.18	5.12(3.15)	1"NPT
ASY35-700DA	31.50	12.99	32.68	13.78	12.20	1.10	4.44	3.94	-	-	-	14.02	8-M30	F35	1.18	5.12(3.15)	1"NPT
ASY40-600DA	27.17	14.96	38.19	15.75	13.78	1.57	7.04	6.30	-	-	-	15.98	8-M36	F40	1.18	5.12(3.15)	1"NPT
ASY40-700DA	31.50	14.96	38.19	15.75	13.78	1.57	7.04	6.30	-	-	-	15.98	8-M36	F40	1.18	5.12(3.15)	1"NPT
ASY40-800DA	35.43	14.96	38.19	15.75	13.78	1.57	7.04	6.30	-	-	-	15.98	8-M36	F40	1.18	5.12(3.15)	1 1/2"NPT
ASY48-800DA	35.43	16.14	44.09	17.72	16.54	1.77	7.91	7.09	-	-	-	19.02	12-M36	F48	1.18	5.12(3.15)	1 1/2"NPT
ASY48-900DA	39.37	16.14	44.09	17.72	16.54	1.77	7.91	7.09	-	-	-	19.02	12-M36	F48	1.18	5.12(3.15)	2"NPT
ASY48-1000DA	43.31	16.14	44.09	17.72	16.54	1.77	7.91	7.09	-	-	-	19.02	12-M36	F48	1.18	5.12(3.15)	2"NPT
ASY60-900DA	39.37	17.32	49.61	20.47	19.69	1.97	9.56	8.66	-	-	-	23.74	20-M36	F60	1.18	5.12(3.15)	2"NPT
ASY60-1000DA	43.31	17.32	49.61	20.47	19.69	1.97	9.56	8.66	-	-	-	23.74	20-M36	F60	1.18	5.12(3.15)	2"NPT
ASY60-1100DA	47.24	17.32	49.61	20.47	19.69	1.97	9.56	8.66	-	-	-	23.74	20-M36	F60	1.18	5.12(3.15)	2"NPT



Double Acting Dimensions of ASY Series Actuator (DA)

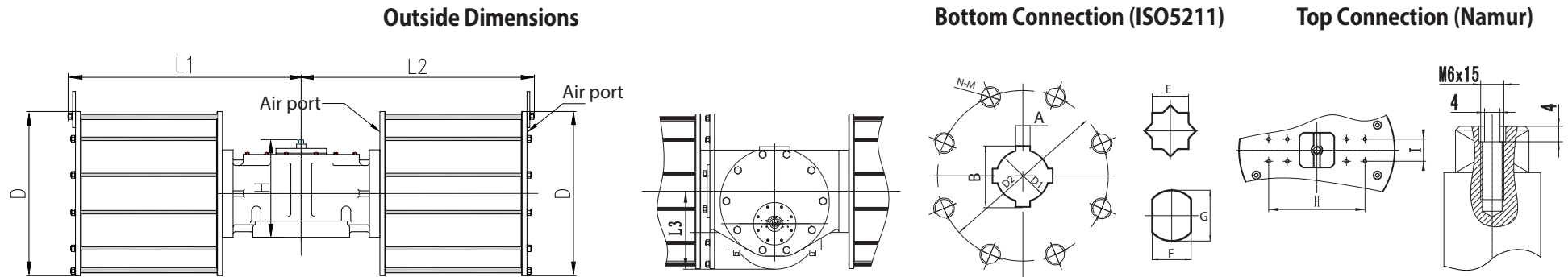

Unit : inches

Model	Outside Dimensions					Female Drive Connection						Flange Connection			Top Connection (Namur)		Air Port
						Keyed (FK)		Double Square (FS)	Double D (FD)								
	D	L1	L2	L3	H	A	B	D1	E	F	G	D2	N-M	ISO5211	I	H	
ASY16-141-DA	7.87	17.32	17.32	7.09	8.27	0.71	2.71	2.36	1.81	1.81	2.37	6.50	4-M20	F16	1.18	3.15	3/8"NPT
ASY16-161-DA	8.66	17.32	17.32	7.09	8.27	0.71	2.71	2.36	1.81	1.81	2.37	6.50	4-M20	F16	1.18	3.15	3/8"NPT
ASY16-201-DA	10.63	17.32	17.32	7.09	8.27	0.71	2.71	2.36	1.81	1.81	2.37	6.50	4-M20	F16	1.18	3.15	3/8"NPT
ASY25-201-DA	10.63	20.08	20.08	8.27	9.06	0.79	3.22	2.83	2.17	2.17	2.84	10.00	8-M16	F25	1.18	3.15	3/8"NPT
ASY25-251-DA	12.60	20.08	20.08	8.27	9.06	0.79	3.22	2.83	2.17	2.17	2.84	10.00	8-M16	F25	1.18	3.15	1/2"NPT
ASY25-301-DA	14.96	20.08	20.08	8.27	9.06	0.79	3.22	2.83	2.17	2.17	2.84	10.00	8-M16	F25	1.18	3.15	1/2"NPT
ASY30-301-DA	14.96	22.83	22.83	9.84	10.83	0.87	3.57	3.15	2.95	2.95	3.87	11.73	8-M20	F30	1.18	5.12(3.15)	1/2"NPT
ASY30-351-DA	16.93	22.83	22.83	9.84	10.83	0.87	3.57	3.15	2.95	2.95	3.87	11.73	8-M20	F30	1.18	5.12(3.15)	1/2"NPT
ASY30-401-DA	18.90	22.83	22.83	9.84	10.83	0.87	3.57	3.15	2.95	2.95	3.87	11.73	8-M20	F30	1.18	5.12(3.15)	3/4"NPT
ASY35-401-DA	18.90	32.68	32.68	13.78	12.20	1.10	4.44	3.94	-	-	-	14.02	8-M30	F35	1.18	5.12(3.15)	3/4"NPT
ASY35-451-DA	20.87	32.68	32.68	13.78	12.20	1.10	4.44	3.94	-	-	-	14.02	8-M30	F35	1.18	5.12(3.15)	3/4"NPT



Double Acting Dimensions of ASY Series Actuator (DA)

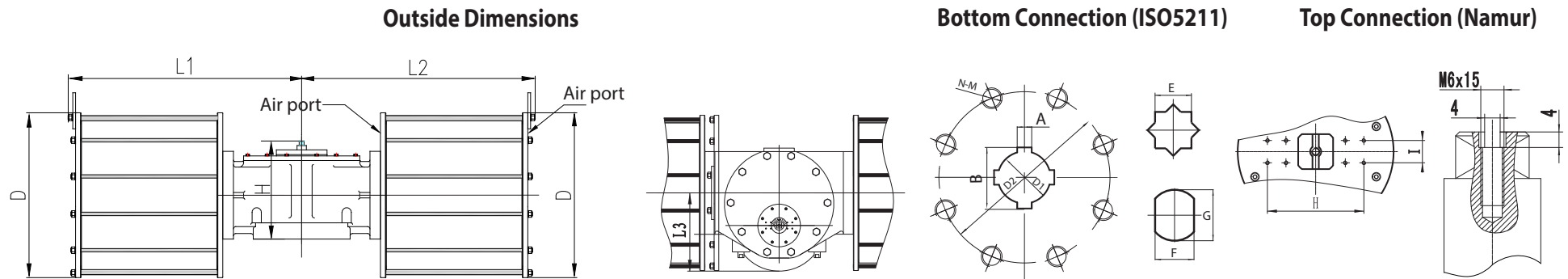

Unit : inches

Model	Outside Dimensions					Female Drive Connection						Flange Connection			Top Connection (Namur)		Air Port
						Keyed (FK)			Double Square (FS)	Double D (FD)							
	D	L1	L2	L3	H	A	B	D1	E	F	G	D2	N-M	ISO5211	I	H	
ASY35-501-DA	22.83	32.68	32.68	13.78	12.20	1.10	4.44	3.94	-	-	-	14.02	8-M30	F35	1.18	5.12(3.15)	3/4"NPT
ASY40-501-DA	22.83	38.19	38.19	15.75	13.78	1.57	7.04	6.30	-	-	-	15.98	8-M36	F40	1.18	5.12(3.15)	3/4"NPT
ASY40-551-DA	24.80	38.19	38.19	15.75	13.78	1.57	7.04	6.30	-	-	-	15.98	8-M36	F40	1.18	5.12(3.15)	3/4"NPT
ASY40-601-DA	27.17	38.19	38.19	15.75	13.78	1.57	7.04	6.30	-	-	-	15.98	8-M36	F40	1.18	5.12(3.15)	1"NPT
ASY48-601-DA	27.17	44.09	44.09	17.72	16.54	1.77	7.91	7.09	-	-	-	19.02	12-M36	F48	1.18	5.12(3.15)	1"NPT
ASY48-651-DA	29.13	44.09	44.09	17.72	16.54	1.77	7.91	7.09	-	-	-	19.02	12-M36	F48	1.18	5.12(3.15)	1"NPT
ASY48-701-DA	31.50	44.09	44.09	17.72	16.54	1.77	7.91	7.09	-	-	-	19.02	12-M36	F48	1.18	5.12(3.15)	1"NPT
ASY48-801-DA	35.43	44.09	44.09	17.72	16.54	1.77	7.91	7.09	-	-	-	19.02	12-M36	F48	1.18	5.12(3.15)	1 1/2"NPT
ASY60-801-DA	35.43	49.61	49.61	20.47	19.69	1.97	9.56	8.66	-	-	-	23.74	20-M36	F60	1.18	5.12(3.15)	1 1/2"NPT
ASY60-901-DA	39.37	49.61	49.61	20.47	19.69	1.97	9.56	8.66	-	-	-	23.74	20-M36	F60	1.18	5.12(3.15)	2"NPT
ASY60-1001-DA	43.31	49.61	49.61	20.47	19.69	1.97	9.56	8.66	-	-	-	23.74	20-M36	F60	1.18	5.12(3.15)	2"NPT



Air Consumption

ASY Series Air Volume Opening & Closing

Model	Volume Opening (L)	Model	Volume Opening (L)
ASY10-150DA	1.68	ASY30-550DA	56.52
ASY10-170DA	2.17	ASY35-550DA	78.89
ASY12-170DA	2.68	ASY35-600DA	93.72
ASY12-200DA	3.69	ASY35-700DA	110.16
ASY14-200DA	4.42	ASY40-600DA	113.87
ASY14-250DA	6.97	ASY40-700DA	155.40
ASY14-300DA	10.03	ASY40-800DA	203.13
ASY16-250DA	8.70	ASY48-800DA	238.56
ASY16-300DA	12.55	ASY48-900DA	302.35
ASY16-350DA	17.14	ASY48-1000DA	373.39
ASY25-350DA	20.56	ASY60-800DA	309.93
ASY25-400DA	26.86	ASY60-900DA	392.80
ASY25-450DA	34.07	ASY60-1000DA	485.10
ASY30-450DA	37.85	ASY60-1100DA	587.47
ASY30-500DA	46.63		

Open Position of ASY Actuators

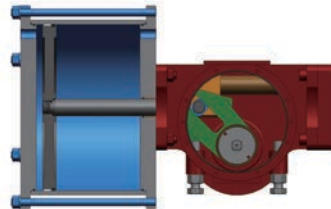

Model	Volume Closing (L)	Model	Volume Closing (L)
ASY10-150DA	1.71	ASY30-550DA	56.99
ASY10-170DA	2.20	ASY35-550DA	79.55
ASY12-170DA	2.72	ASY35-600DA	94.67
ASY12-200DA	3.77	ASY35-700DA	111.11
ASY14-200DA	4.52	ASY40-600DA	115.02
ASY14-250DA	7.07	ASY40-700DA	156.55
ASY14-300DA	10.17	ASY40-800DA	204.48
ASY16-250DA	8.83	ASY48-800DA	240.15
ASY16-300DA	12.72	ASY48-900DA	303.94
ASY16-350DA	17.31	ASY48-1000DA	375.23
ASY25-350DA	20.77	ASY60-800DA	311.99
ASY25-400DA	27.13	ASY60-900DA	394.86
ASY25-450DA	34.34	ASY60-1000DA	487.49
ASY30-450DA	38.15	ASY60-1100DA	589.86
ASY30-500DA	47.10		

Close Position of ASY Actuators

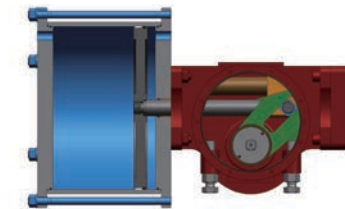

Air consumption rest with Air Supply. Air volume and Action cycle times, expressions:

$$L/Min = \text{Air volume}(\text{Air volume Opening} + \text{Air volume closing}) \times [(\text{Air Supply}(Kpa) + 101.3) \div 101.3] \times \text{Action cycle times (/min)}$$



ASY Series Scotch Yoke Pneumatic Actuators can be equipped with additional devices (manual overrides and travel stoppers) to meet any special requirements, such as the assembly debugging in test runs, emergency shut down in power failure, and safety travel stop in the operation of quick stroke within 5s.

Hand Wheel Override (HW). As for ASY10-XXSR to ASY16-XXSR actuators, the hand wheel manual overrider is armed on the side of the spring cartridge. Note that this kind of hand wheel manual override is also available for ASY Series Double Acting Actuators.

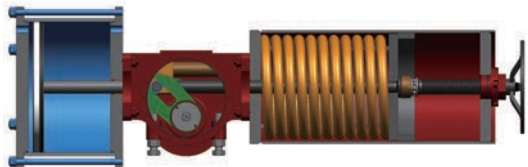

Open position operated by hand wheel.

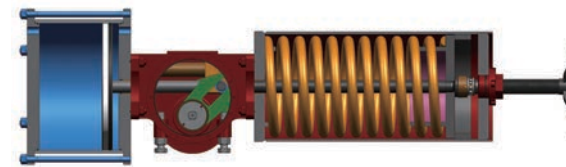

Closed position operated by hand wheel.

Hydraulic Override (HY). As for ASY25 to ASY60 Series Actuators, the hydraulic overrides are available both for double acting and spring return.

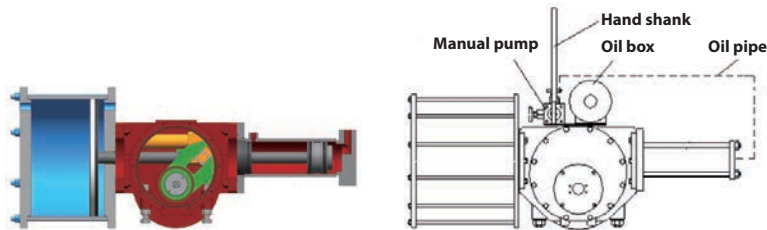

ASY Double Acting actuator with Hydraulic Override.

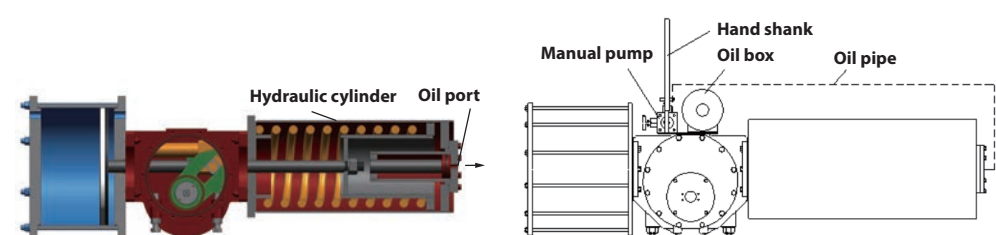

ASY Spring Return Actuator Hydraulic Override

Extended Mechanical Travel Stop (EX). As a standard configuration, ASY yoke mechanism fitted with mechanical end stops (open or closed positions) inside of center body to ensure adjustable range of $\pm 6^\circ$. For quick stroke operation within 5s, ASY offers an extended mechanical travel stop (EX) in each end of the actuator to ensure the travel stop safely adjust to a range of $\pm 6^\circ$ at stop positions reliably.

Double acting ASY actuators are built with EX stops.

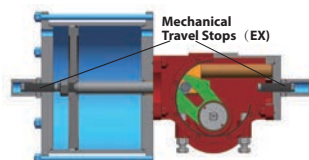

Spring return ASY actuators are built with EX stops.

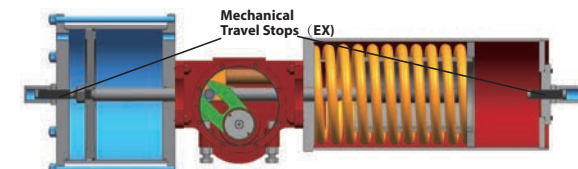

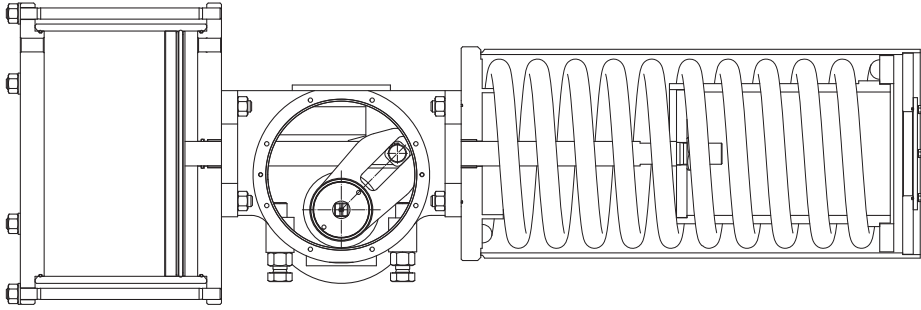
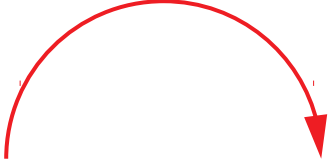
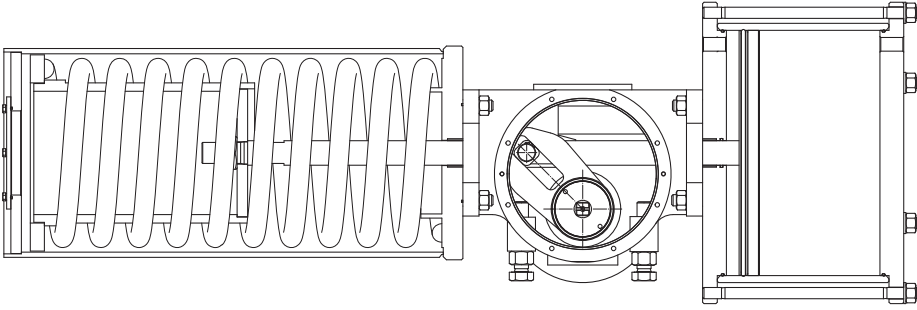
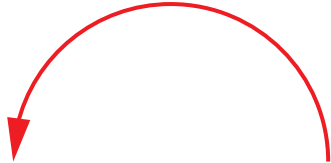

As for ASY Spring Return Actuators, fail-close or fail-open modules are depended on the configuration. Because of sharing modular construction, these modules can be required when ordering or reconfiguration by the customer.

Spring Return Actuator Configuration	Fail Direction	
 <p data-bbox="286 826 1066 916">Cylinder Module is on the left side Spring Cartridge Module is on the right side</p>	<p data-bbox="1249 651 1570 740">CW Fail to Closed (FC)</p>	
 <p data-bbox="300 1337 1052 1426">Cylinder Module is on the right side Spring Cartridge Module is on the left side</p>	<p data-bbox="1261 1139 1559 1228">CCW Fail to Open (FO)</p>	



Flo-Tite is available to supply accessories, such as ALV Series Solenoid Valves, ALS Series Limit Switch Boxes, ALP Series Valve Positioners, which can be assembled with ASY Scotch Yoke Actuators based on Namur and ISO5211 standards. These accessories can be mounted on a panel, in a cabinet, or mounted on the actuator directly.



AIR-CON

Flo-Tite, Inc.

4815 W 5th Street
Lumberton, NC 28358

Tel:(910) 738-8904

Website:www.flotite.com

P.O. Box 1293
Lumberton, NC 28358

Fax:(910)738-9112

E-mail:flotite@flotite.com